

J030



Material

All parts from AISI 304 stainless steel, satin finish. Fixing screws not included.



Draw Latches, Spring Loaded

stainless steel

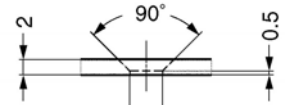
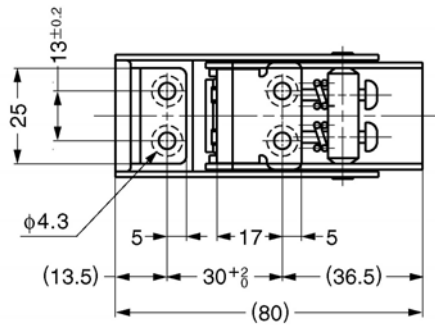
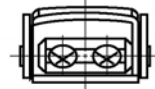
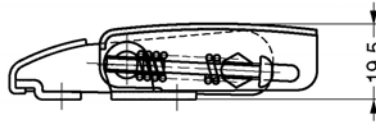
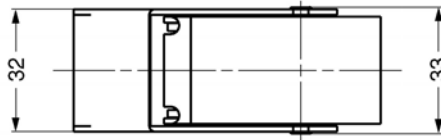

Countersunk hole

Order No.	Load Capacity Kg	g
J030.AC030	80	110

J032



Material

All parts from AISI 304 stainless steel, satin finish. Fixing screws not included.



Draw Latches

stainless steel

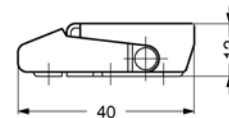
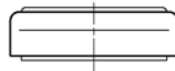
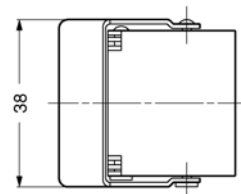
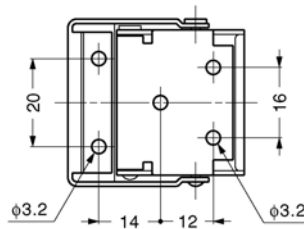

Order No.	g
J032.AC030	30