

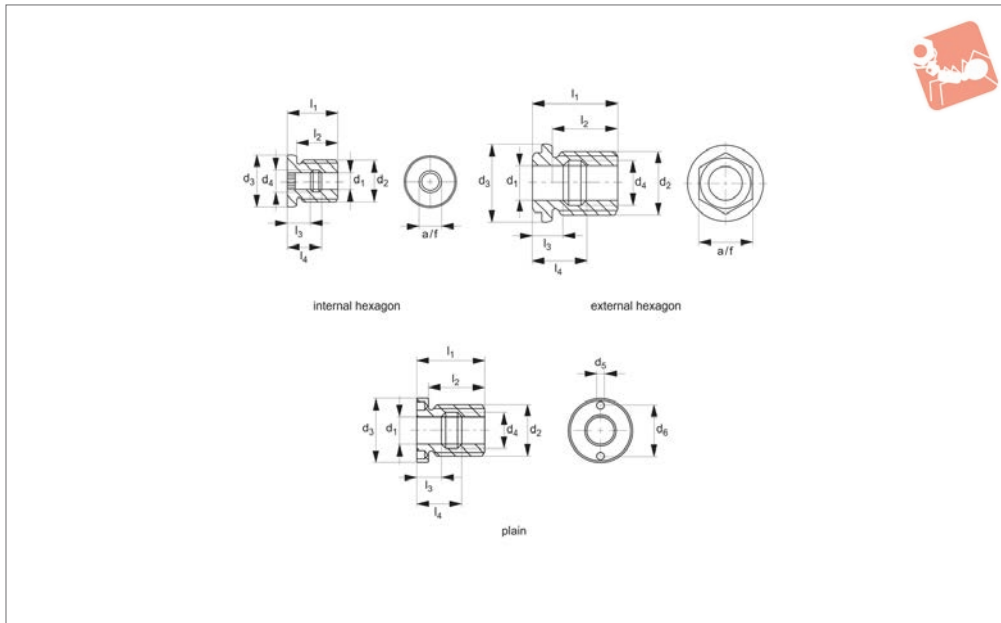

Locating Bushes for ball lock pins

Ball Lock Pins & Quick Release



33248

BALL LOCK PINS & QUICK RELEASE PINS

Material

Body: stainless steel 1.4305. (AISI 303).

Technical Notes

For quick and safe location of single acting ball lock pins - especially in soft materials such as aluminium, or in thin walled

components.

Can be used from both sides. Optimised centering due to precision collar on bush.

Important Notes

l_5 and l_6 refer to depths of ball locating recess when bush is installed flange collar

up, or flange collar inverted (see diagram below).

Use pin face spanner with 5mm pin to install pin mount bushings.

Order No.	Type	d_1 tol. H11	d_2	d_3 tol. h9	d_4	d_5	d_6	Weight g
33248.W0905	Int Hex	5	M12	18	6.0	-	-	15
33248.W0906	Int Hex	6	M12	18	7.5	-	-	13
33248.W0908	Int Hex	8	M16	22	10.0	-	-	29
33248.W0910	Int Hex	10	M24	30	12.5	-	-	75
33248.W0912	Int Hex	12	M24	30	15.0	-	-	66
33248.W0916	Ext Hex	16	M30	36	19.5	-	-	124
33248.W0920	Ext Hex	20	M36	45	25.5	-	-	208
33248.W0924	Ext Hex	25	M42	50	32.0	-	-	415
33248.W0925	Plain	16	M30	39	19.5	5.1	30	160
33248.W0926	Plain	20	M36	43	25.5	5.1	30	257
33248.W0927	Plain	25	M42	50	32.0	5.1	36	434

Order No.	l_1	l_2	l_3	l_4	l_5	l_6	A/F
33248.W0905	19	15	9.0	13.0	5.1	9.0	5
33248.W0906	19	15	9.4	13.0	5.6	8.8	6
33248.W0908	25	20	12.0	17.0	7.3	11.7	8
33248.W0910	29	24	13.5	19.5	8.9	14.1	10
33248.W0912	29	24	14	20	9.6	14.4	12
33248.W0916	39	29	15.5	23.5	6.1	12.8	24
33248.W0920	49	38	17.5	31.5	7.7	19.3	30
33248.W0924	65	50	26.5	38.5	13.3	21.8	36
33248.W0925	39	33	15.5	23.5	10.4	16.6	-
33248.W0926	49	42	17.5	31.5	11.9	23.1	-
33248.W0927	65	57	26.5	38.5	13.3	21.8	-





Wixroyd Ball Lock Pins

applications

33060 - 33250
Positioning Elements



Sound Rigging Systems

Ball lock pins on a sound rigging system. Offering secure fixing with high shear forces and easy fitting for operators at heights.

In addition full black powder coating of grip and actuation button eliminates glare from other stage lighting.

BALL LOCK PINS & QUICK RELEASE PINS

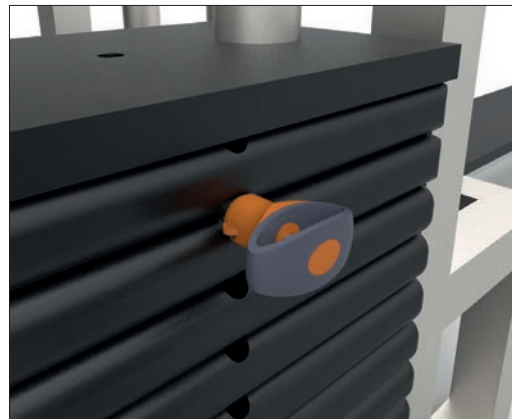
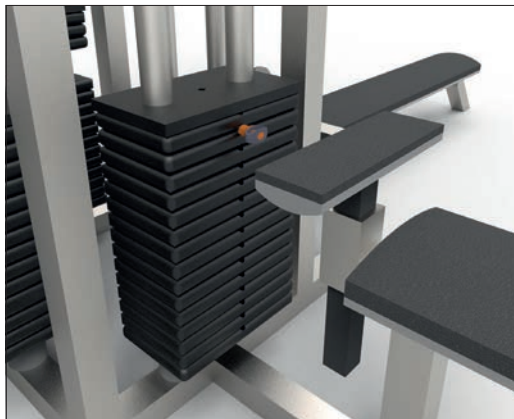

Gym Equipment

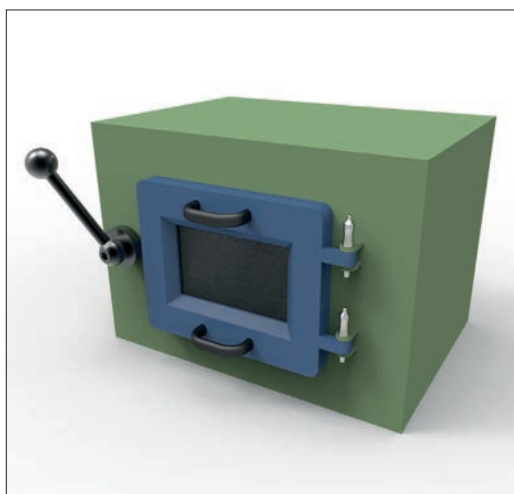

Scientific and Medical

ov-W33060.BK-A-TOR1706-W33250-A-TLA1066-a-rmh - Updated - 27-10-2022



Pin Material

1.4305 (AISI 303) - shear force approx. 60% of higher material version 1.4542

1.4542 (AISI 630) - identified by the ridge on the pin

CRES 17-4PH (AMS 5643) aviation standard



Handle Style



Plastic tri-star



T-handled, metal



L-handled, metal

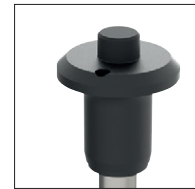

Mushroom, metal



Single piece metal, contoured



Special plastic self-spring



Adjustable grip length, plastic



Key ring



Safety, metal



Mushroom Type B aviation

Type R aviation

Lanyards and Locating Bushes



Stainless wire - (coated) - 2 x key ring



Stainless wire - Key ring and fixing loop



Plastic - 2 x cable tie



Steel wire - (coated) - 2 x key ring



Stainless bead chain - 2 x key ring



Locating bushes

Actuation



Press = unlock
Release = lock (standard)



Press = unlock and position
Release = lock and simultaneous clamp



Simple spring loaded balls "pullout pin"

Important Note

Important Note: Ball lock pins are not suited to lifting applications!
For quick release lifting pins, see part 33400.



Shear force

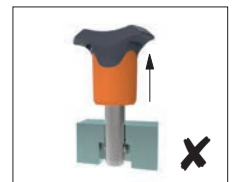

Lifting force

Special Variations



Variations on our standard designs are possible, please contact our sales team for technical assistance. Quick production on specials can be as little as 3 weeks.



Applications

- Positioning.
- Lifting.
- Locking.
- Indexing.
- Joining.

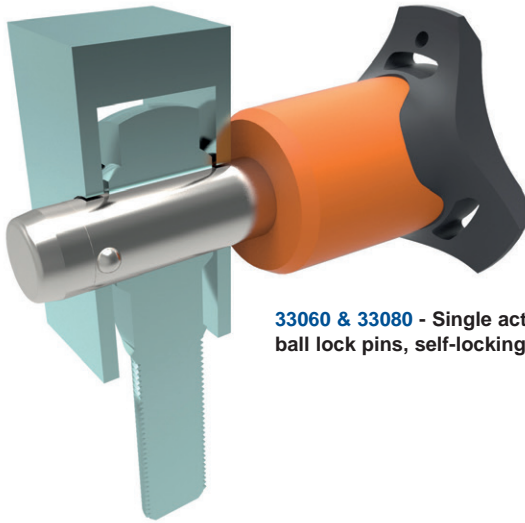

33060 & 33080 - Single acting ball lock pins, self-locking.



33194 - Single acting ball lock pins, self locking, simple finish.



33140 - Socket pins, non-locking, spring loaded balls.



33100 - Single acting ball lock pin, self locking.



33180 - Clamping pins, with span compensation, self-locking.

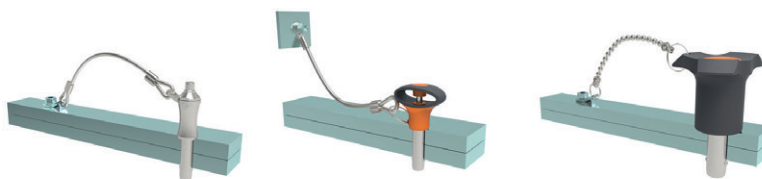

33250 & 33270 - Lanyards.



33220 - Ball lock pins, single acting - L-handle

BALL LOCK PINS & QUICK RELEASE PINS

ov-W33060.BK-A-TOR1706-W33250-A-TL1A1066-c-rmh - Updated - 27-10-2022