



Panel Latches

uncovered - square driver - steel



Cam Latches

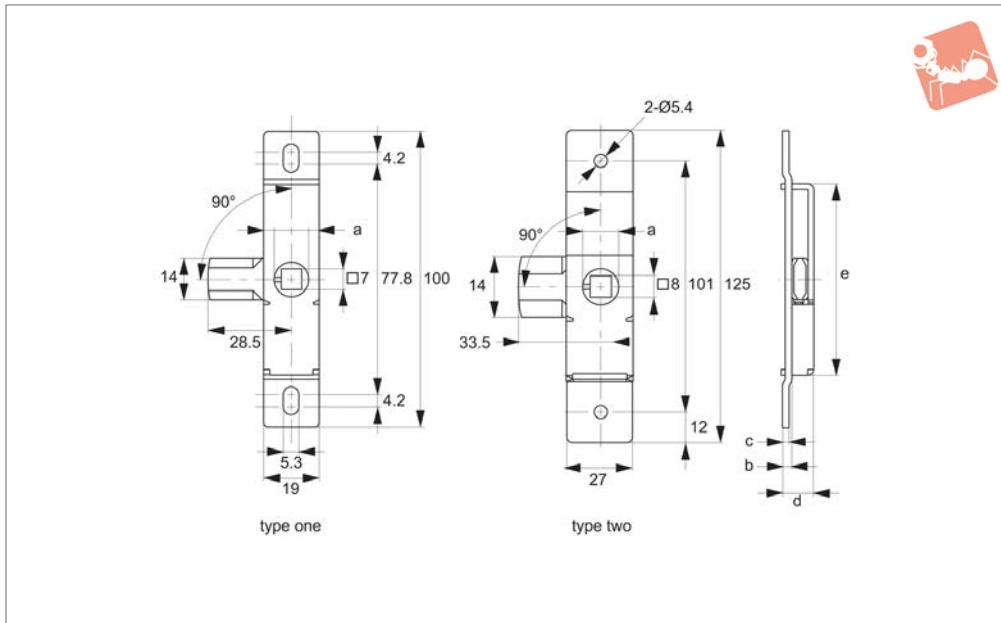

A1546

CAM LATCHES

Material

Body & insert: Q235 steel, zinc plated.
Supplied with: Cam: stainless steel.

Technical Notes

Can be used with a square 7 or 8 square bar for handle/key opening.

Fix internally to panels or enclosures via rivets, or M 5 screws (not supplied).

Order No.	Insert type	Type	a	b	c	d	e
A1546.AW0012	Square 7	Type One	12	3.0	2.0	10.4	65.0
A1546.AW0015	Square 8	Type Two	15	3.5	2.5	15.1	76.2



When selecting a Wixroyd Cam Latch for your application, you need to answer these questions:

1. Which installation cut out?
2. Which body style?
3. Which locking key?
4. Which accessories?
5. Which cam type and size?

Step 1: Which installation cut out?

Cut out

All our Flexi-System cam latches use a standard installation cut out 22,2 dia, 20,2 square, for maximum flexibility. We also provide a number of alternative cut out dimensions for legacy/historical installations.

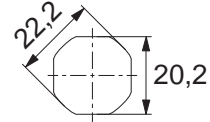

flexi-system cut out

Step 2: Which body style?

Material and finish

Select from our variety of die cast zinc, polyamide plastic and stainless versions.



Die-cast zinc chrome plate

Die-cast zinc black coated

Polyamide black

Stainless steel

Actuation and locking method

Standard insert driver type, cylinder lock or wing handle type.



Insert driver

Cylinder lock

Wing handle

Number of latching points in application

Typically single point latching is required, but the Wixroyd Flexi-System also provides multi-point latching (typically 3 point - at lock point, top and bottom of cabinet).



Single point

Two point

Multi-point

Step 3: Which locking key?

Standard insert driver keys

Our range of insert driver cam latches require a simple key to actuate. Refer to part A0102 and A0103 for correct keys.



Cylinder locking

Our cam locks with cylinder locks are supplied with two keys per lock. Available as keyed alike or keyed to differ locks.



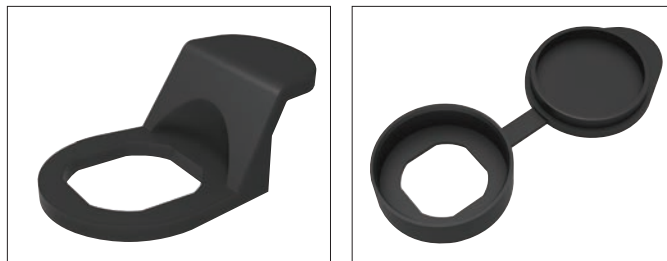

Step 4: Which accessories?

- Multi-point latching: use our rod set A0303 to A0325 for suitable rods and rod guides.
- Finger pulls: easily installed with any of our flexi-system cam bodies, finger pull no. A0352 is a simple, cost effective handle for your cabinets.
- Dust Cap: to reduce material ingress.





Miscellaneous Cut out	Actuation Method	Body	Finishes	Cam Type
Insert Driver Cylinder Lock Manual/Grip	Body length (mm)	Die-Cast Zinc Polyamide Plastic Stainless Steel	Chrome Plated Black Coated Natural	With Projection W/O Projection IP Rating
A1192 - Mini Cam Latch - Wing Handle - Fixed Grip				
	✓ 10	✓	✓	
Cams: Supplied - Keys: N/A				
A1506 - Panel Latches - Fixed Grip				
	✓ 25		✓	54
Cams: Supplied - Keys: A0102				
A1520 - Cam Lock - Fixed Grip				
	✓ 18	✓		✓
Cams: Supplied - Keys: A0102				
A1546 - Panel Latch - Uncovered				
	✓	✓	✓	
Cams: Supplied - Keys: N/A				
A1561 - Panel Latch - with Cover				
	✓ 22,5	✓		✓
Cams: Supplied - Keys: N/A				
A1701 - Compression Latch - Lever Latch - Flush Trigger				
	✓	✓	✓	
Cams: N/A - Keys: Supplied				
A1707 - Compression Latch - Lever Latch - Raised Trigger				
	✓ 19	✓		✓
Cams: Supplied - Keys: Supplied				
A1751 - Compression Latch - Lever Latch				
	✓	✓	✓	
Cams: N/A - Keys: Supplied				

Miscellaneous Cut out	Actuation Method	Body	Finishes	Cam Type
Insert Driver Cylinder Lock Manual/Grip	Body length (mm)	Die-Cast Zinc Polyamide Plastic Stainless Steel	Chrome Plated Black Coated Natural	With Projection W/O Projection IP Rating
A4241 - Cam Latch - with Rod Control - Extended Cover				
	✓	✓		✓ 40
Cams: A0203, A0224, A0240 - Keys: A0102				
A4260 - Cam Lock - with Rod Control - Wing Handle - Extended Cover				
	✓	✓		✓ 54
Cams: A0203, A0224, A0240 - Keys: A0102				
A4221 - Cam Latch - with Rod Control - with Cover				
	✓	Various ✓		✓ ✓
Cams: A0203, A0224 - Keys: A0102				

CAM LATCHES



With or without "Projection"

Different cam bodies require cams either with or without projection.

Step 5:

Which cam type and size?

Wixroyd cams are available in a number of different materials; zinc plated steel, stainless steel (AISI 304) and black plastic.

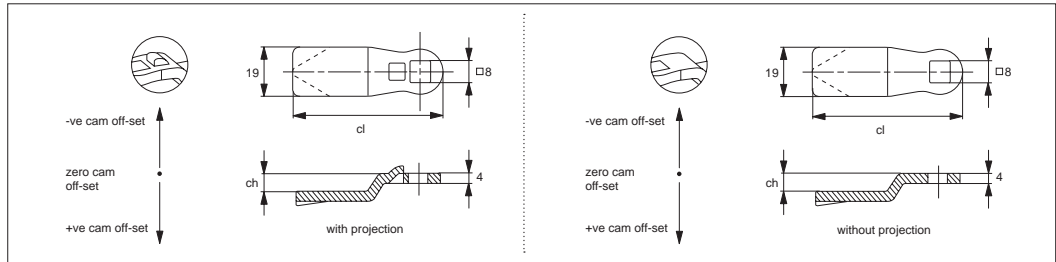

With projection cams prevent turning of the cam over 45° , but is not suited to all cam bodies. For correct projection type please see individual cam body technical pages.

Number of Latching Points

Single point cams are suitable where just single point latching is required. Multi-point cams are for applications requiring 2 or 3 latching points.

Calculation of correct cam off-set

This is the most important aspect of the selection process.

Cam off-set (dimension ch)

To ensure your cam fully and correctly engages with the frame of your door the correct cam off-set must be selected. A cam off-set can be either negative (-ve) or positive (+ve).

Cam length (dimension cl)

This impacts the reach of the cam to door frame and hence impacts positioning of cam body for installation. Cam length is measured from the centre of the cam fixing hole to the cam's leading edge. Most typically cams are 45 mm in length.

Use formula to calculate ch (required cam off-set), and refer to the cam selection chart.

$$ch = h - lh \text{ where;}$$

ch = the required cam off-set/height

h = grip length (distance between inside of latch face and front of cam).

lh = body length of cam latch/lock to be used (see example below)

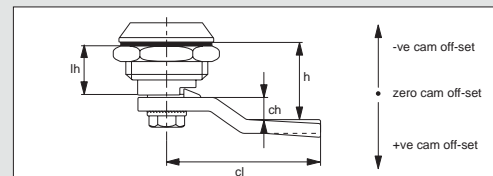

Example of calculation of correct cam off-set

Example one

Cam body A1003.AW0010 has been selected for the application. If we refer to the data sheet for this part, suitable cams are parts A0203, A0210 or A0240 - "without projection".

Known application information: $h = 26$ $lh = 18$

Therefore; $ch = 26 - 18 = +8$

Cam off set of +8 is required

Using the data tables for cams A0203, A0210, and A0240 we can select the following cams without projection with an off set of +8; A0203.AW5408 (steel), A0210.AW0428 (stainless) or A0240.AW0108 (three point cam).

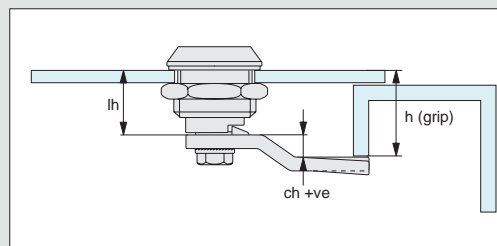

Example two

Cam body A1003.AW0010 has been selected for the application. If we refer to the data sheet for this part, suitable cams are parts A0203, A0210 or A0240 - "without projection".

Known application information: $h = 14$ $lh = 18$

Therefore; $ch = 14 - 18 = -4$

The required cam off set is negative, -4 as the application's door frame is effectively shorter/lower than the length of the cam body

Using the data tables for cams A0203, A0210 and A0240 we can select the following cam without projection with an off set of -4; A0203.AW6404 (steel).

