

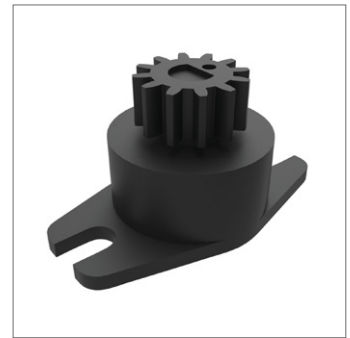

# Rotary Dampers

bi-directional - continuous rotation - up to 400gf.

# Rotary Dampers

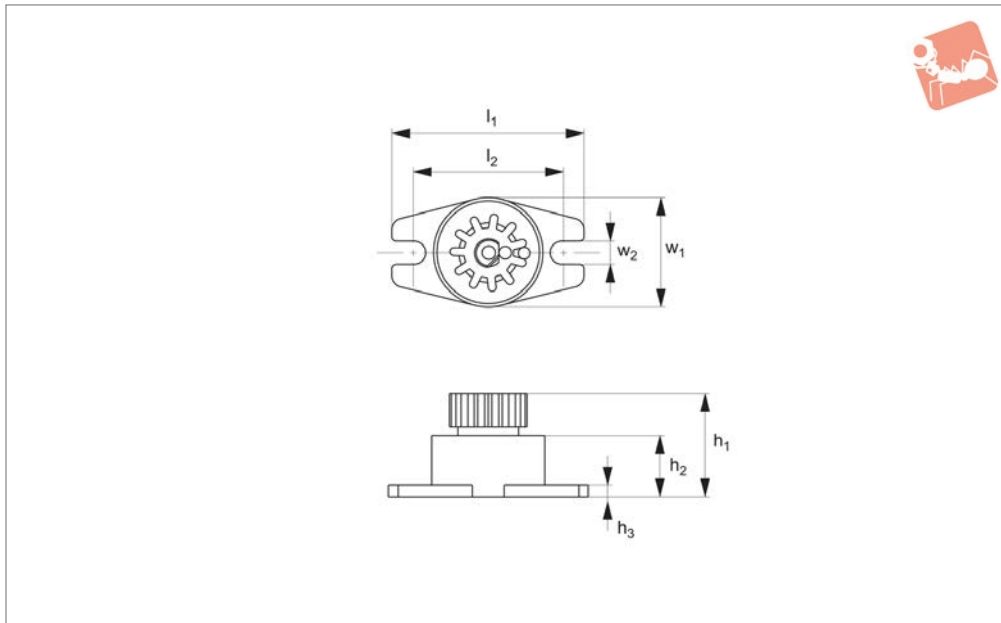

**Q3042**

ROTARY DAMPERS

**Material**

Polycetal (POM), polycarbonate (PC)

in applications such as loading trays, arm rests and storage compartments. Subject to minimum order quantity.











**Tips**

Create smooth movement and dampening

Order No.	Damping direction	Torque gf-cm	No. of teeth	Gear module	Pitch circle diameter P.C.D	Pressure angle	$l_1$	$h_1$	$h_2$	$h_3$	$w_1$	$w_2$
Q3042.AC0400	Anti-clockwise	80-120	11	0.6	8.8	20	27.5	14	8.5	1.5	15	3.2
Q3042.AC0410	Clockwise	80-120	11	0.6	8.8	20	27.5	14	8.5	1.5	15	3.2
Q3042.AC0420	Anti-clockwise	60-80	11	0.6	8.8	20	27.5	14	8.5	1.5	15	3.2
Q3042.AC0430	Clockwise	60-80	11	0.6	8.8	20	27.5	14	8.5	1.5	15	3.2



## Product selection chart

Part no.	Damping direction	Torque gf.cm	Rotary dampers													
			Torque gf.cm													
			20	40	60	80	100	200	300	400	500	1000	1500			
	Q3000	Two way	10 - 40													
	Q3020	Two way	20 - 100													
	Q3022	Two way	50 - 150													
	Q3024	Two way	50 - 150													
	Q3026	Two way	15 - 50													
	Q3027	Two way	15 - 50													
	Q3028	Two way	15 - 50													
	Q3029	Two way	70 - 150													
	Q3031	Two way	50 - 150													
	Q3032	Two way	50 - 100													
	Q3033	Two way	50 - 150													
	Q3036	Two way	15 - 50													
	Q3040	One/two way	200 - 300													
	Q3042	Two way	100 - 400													
	Q3044	Two way	100 - 400													
	Q3060	One/two way	500 - 1500													



# Rotary Dampers

bi or uni-directional continuous rotation

Q3000 - Q3060

Rotary & Torque Dampers

ROTARY DAMPERS

Wixroyd rotary dampers offer controlled opening and closing of lids, drawers, covers and much more, they provide a range of solutions for a variety of applications creating smooth movement and function.

Though unnoticed in many applications, rotary dampers are a vital part of many products bringing quality, safety and durability. Rotary dampers provide quality movement enhancing both touch and feel. Available in unidirectional (single) dampening, or bi-directional (double) version. Also available with or without gears.

**Solution for controlled opening and closing motion**



Rotary dampers utilise the principle of fluid resistance to reduce the speed of moving parts. The oil viscosity is utilised to provide the “braking force” of the damper. The torque or “braking force” can be adjusted by changing the viscosity of the oil. The advantages of the rotary type dampers are their compact size.

**Rotary dampers**

- Loading trays for CD, DVD, VCR, MD players.
- Arm rests, ashtrays, center consoles, glove boxes, handles and storage compartments in passenger vehicles.
- Camcorders, celular phones and small personal devices.

**Applications**

Rotary dampers utilise the movement of fluid forced from one chamber to another via a rotor. Dampening speed is dependent upon the viscosity of the fluid and the diameter of the fluid aperture.

Through the use of toothed plastic rack no. Q3150, rotary dampers with gears can be used to dampen on a linear plane rather than the normal dampening directly at the shaft.

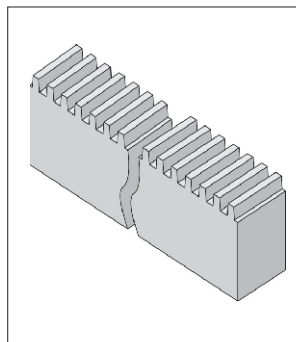

Part no.	Q3200 to Q3260
Max. speed	50rpm
Max. cycle rate	10 cycles/min
Nominal torque rating	At 20rpm, 23°C (73°F)
Operating temperature	0 to 50°C (32 - 122°F)
Storage temperature	-20 to 60°C (-4 to 140°F)

**Operating principle**

To calculate the torque for your application, the following measurements are necessary.

$$t \text{ (torque)} = w \times 0.5 \times h$$

h = length from pivot point to end of lid (cm)

w = weight of the lid (Kg)

Torque force stated per product (see individual product pages), is the maximum torque to which the specified part can be exposed before the dampening force yields and hence dampening is overcome.

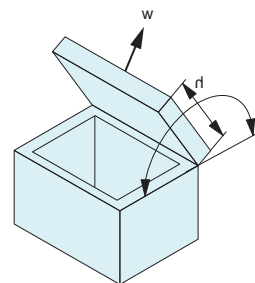

**Torque calculation**

**Note**

Dampening direction is determined whilst looking directly onto the output shaft.

**Important**

Avoid side loading of the disk damper output shaft in order to maximise effectiveness.

**Important note: Once calculation has been made choose a disk damper from our range which can accommodate the newly calculated torque of the application. Use the damper closing speed graphs opposite to confirm that the rpm given at the corresponding torque value matches the desired lid closing speed. If the desired rpm is beyond the capacity of the selected damper, then select another damper with a higher torque rating and re-test. If the rpm is too slow select another damper with a lower torque rating and re-test.**